

Version

[English](#)

NETWORK SETUP

For Video Recorder

Please read instructions thoroughly before operation and retain it for future reference.

We reserve the right to revise or remove any content in this manual at any time.
We do not warrant or assume any legal liability or responsibility for the accuracy, completeness, or usefulness of this manual.
The content of this manual is subject to change without notice.

1. BEFORE STARTED

Note: Network configurations may require a person who has advanced network knowledge. It's recommended to check with your installer for this service if possible.

Understand How Your Laptop / Computer Connect to Internet

1. Router + Modem

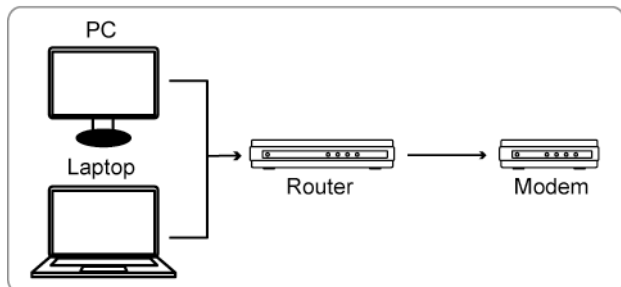

2. Modem or Modem + Hub

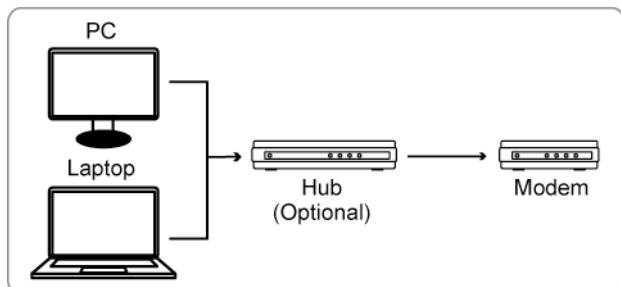

→ Devices connected with a RJ45 network cable

Then, connect your video recorder directly to your router / hub / modem with a network cable, and power it on.

If you're using:

- Router + modem, please refer to "2. Router + Modem" at page 2.
- Modem or modem + hub, please refer to "3. Modem / Hub + Modem" at page 5.

2. Router + Modem

Before configuring, make sure:

- Your laptop / PC is connected to the same router as the video recorder is intended to connect to.
- You know the IP address, user name and password to access your router.
- The DHCP function of your router is on.

Note: For details, please refer to the user manual of your router.

- The setup of your video recorder is completed as instructed in its user manual, and it's powered on.



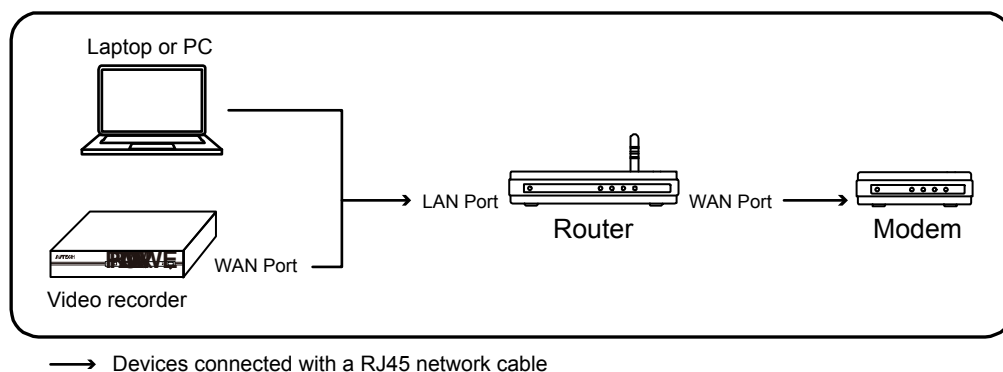

Note: For details, please refer to the user manual of your video recorder.

Step1: Connect your video recorder to the router with a RJ45 network cable, similar as follows:



Step2: Go to “ADVANCED CONFIG” from the main menu.

Based on the model you have, “ADVANCED CONFIG” could be accessed by either:

- Selecting  on the live view, or
- Right-clicking to show the main menu, and select  or  or .

Then, select “Network” → “WAN”, or

ADVANCED CONFIG				
CONNECTION	WAN	LAN	E-MAIL	DDNS
CAMERA	NETWORK TYPE		DHCP	
DETECTION	IP		192.168.1.112	
ALERT	GATEWAY		192.168.1.254	
NETWORK	NETMASK		255.255.255.0	
DISPLAY	PRIMARY DNS		168.095.1.1	
RECORD	SECONDARY DNS		139.175.55.244	
	PORT		88	
EXIT				

“Network” → “NETWORK”.

ADVANCED CONFIG					
CAMERA	NETWORK	SNTP	FTP	E-MAIL	DDNS
DETECTION	NETWORK TYPE		DHCP		
ALERT	IP		192.168.001.010		
NETWORK	GATEWAY		192.168.001.254		
DISPLAY	NETMASK		255.255.255.000		
RECORD	PRIMARY DNS		168.095.001.001		
DEVICES	SECONDARY DNS		139.175.055.244		
	PORT		0080		
EXIT					

Step3: Select "DHCP", and configure the DNS setting and port number.

Note: DNS is the domain name server obtained from your ISP (Internet Service Provider).

Note: The default port number is 80. Typically, the TCP port used by HTTP is 80. However in some cases, it is better to change this port number for added flexibility or security.

Then, note down the IP address shown in "IP". This is the IP address assigned to your video recorder by the router. You'll need it later for port forwarding.

Step4: Go to "DDNS", and select "eagleeyes" in "SYSTEM NAME".

Note down the whole address under "CURRENT HOST ADDRESS", such as *MAC000E5318B3F0.ddns.dvrtw.com.tw*. This will be the address used to access your video recorder remotely.

ADVANCED CONFIG				
CONNECTION CAMERA DETECTION ALERT NETWORK DISPLAY RECORD NOTIFY	WAN	LAN	E-MAIL	DDNS
	DDNS			ON
	SYSTEM NAME			eagleeyes
	HOST NAME			MAC000E5318B3F0
	E-MAIL			EMPTY
CURRENT HOST ADDRESS				
EXIT				MAC000E5318B3F0.ddns.dvrtw.com.tw

Then, select "EXIT" to return to the live view, and continue to Step5 for port forwarding.

Step5: Open Internet Explorer® from your laptop / PC, and enter the IP address of your router to access your router. Enter the user name and password if needed.

Note: Internet Explorer is the registered trademark of Microsoft Corporation in the United States and other countries.

Step6: In the router setting interface, go to the port forwarding (or virtual server) rule configuration page.

Note: The naming of port forwarding or virtual server may vary based on different router brands. To know where it is, please refer to the user manual of your router.

Then, enter the IP address and the port number you note down in Step3, and enable this rule.

Take D-Link router as an example:

Go to "ADVANCED" → "PORT FORWARDING".

DIR-635	SETUP	ADVANCED	TOOLS	STATUS	SUPPORT
VIRTUAL SERVER	PORT FORWARDING				Helpful Hints...
PORT FORWARDING	This option is used to open multiple ports or a range of ports in your router and redirect data through those ports to a single PC on your network. This feature allows you to enter ports in various formats including, Port Ranges (100-150), Individual Ports (80, 68, 888), or Mixed (1020-5000, 689). This option is only applicable to the INTERNET session.				
APPLICATION RULES	Save Settings Don't Save Settings				Check the Application Name drop down menu for a list of predefined applications. If you select one of the predefined applications, click the arrow button next to the drop down menu to fill out the corresponding field.
QOS ENGINE	24 -- PORT FORWARDING RULES				
NETWORK FILTER	Name	Application Name	Ports to Open	Schedule	
ACCESS CONTROL	<input checked="" type="checkbox"/> my home	<< Application Name	TCP 88	Always	
WEBSITE FILTER	IP Address	<< Computer Name	UDP 88	Inbound Filter	
INBOUND FILTER	192.168.1.112			Allow All	
FIREWALL SETTINGS					
ROUTING					
ADVANCED WIRELESS					

IP Address:	The IP address of the video recorder, such as <i>192.168.1.112</i> in our example.
Ports to Open:	The port number you set for the video recorder, such as <i>88</i> in our example.

Check your connection – via Internet Explorer

Step1: Disconnect the network connection between your laptop and the router, and connect your laptop to other wireless network if possible.

Note: If there's no other wireless connection available for your laptop, this method is not suitable for you. Please go to the next section, "**Check your connection – via iOS® / Android™ mobile device**".

Step1: Open your web browser, e.g. Internet Explorer.

Step2: Enter the address and the port number in the URL address box of the web browser, and see if you can access the login page successfully.

The format is "**http://hostaddress:portnum**", such as "**http://MAC000E5318B3F0.ddns.dvrtw.com.tw:88**" in our example.

If no, the network setup is failed. Please start from Step1 again.

Check your connection – via iOS® / Android™ mobile device

Step1: Download our free mobile app, EagleEyes, from App StoreSM (iOS device) or Google PlayTM (Android device).

Note: App Store is a service mark of Apple Inc. iOS is the trademark of Apple Inc., registered in the U.S. and other countries. Google Play is the trademark of Google Inc.

Step2: Switch the network mode to 3G mode or other wireless network on your iOS / Android device.

Step3: Open EagleEyes, and select "Manual" when you're prompted to choose the setup method.

Step4: Click "+" on the bottom to enter the configuration page.

Then, enter the address, port number, user name and password of your video recorder.

In our example, the address is **MAC000E5318B3F0.ddns.dvrtw.com.tw**, the port number is **88**, and the user name and password are both **admin** by default (if they haven't been changed).

Step5: Select "Get Type" to see if you can get the type of your video recorder. If no, the network setup is failed. Please start from Step1 again.

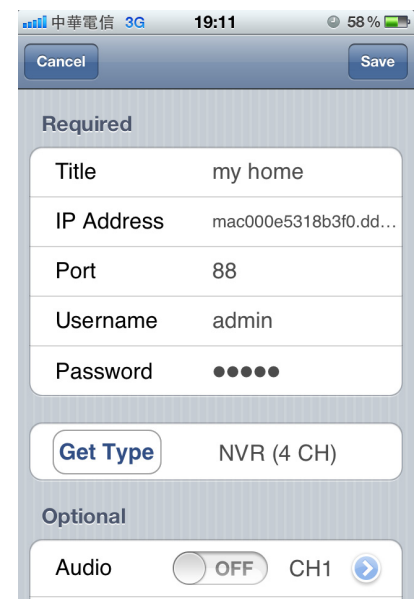

3. Modem / Hub + Modem

Before configuring, make sure:

- You know you're using static IP address or PPPoE for Internet service.
- For users with static IP address, make sure you get the information of the static IP address, gateway and net mask from your ISP (Internet Service Provider).
- For users with PPPoE, make sure you get the user name and password from your ISP (Internet Service Provider).
- The setup of your video recorder is completed as instructed in its user manual, and it's powered on.



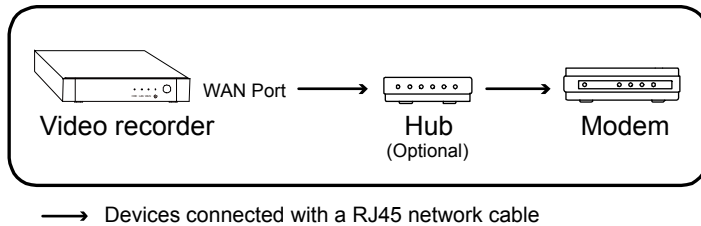

Note: For details, please refer to the user manual of your video recorder.

Step1: Connect your video recorder to the hub or modem with a RJ45 network cable, similar as follows:



Step2: Go to “ADVANCED CONFIG” from the main menu.

Based on the model you have, “ADVANCED CONFIG” could be accessed by either:

- Selecting  on the live view, or
- Right-clicking to show the main menu, and select "" or "" or "".

Then, select “Network” → “WAN”, or

ADVANCED CONFIG	
CONNECTION	WAN LAN E-MAIL DDNS
CAMERA	NETWORK TYPE DHCP
DETECTION	IP 192.168.1.112
ALERT	GATEWAY 192.168.1.254
NETWORK	NETMASK 255.255.255.0
DISPLAY	PRIMARY DNS 168.095.1.1
RECORD	SECONDARY DNS 139.175.55.244
	PORT 88
	INTERNET AVAILABILITY ADDRESS www.google.com
EXIT	

“Network” → “NETWORK”.

ADVANCED CONFIG	
CANERA	NETWORK SNTP FTP E-MAIL DDNS
DETECTION	NETWORK TYPE DHCP
ALERT	IP 192.168.001.010
NETWORK	GATEWAY 192.168.001.254
DISPLAY	NETMASK 255.255.255.000
RECORD	PRIMARY DNS 168.095.001.001
DEVICES	SECONDARY DNS 139.175.055.244
	PORT 0080
EXIT	

Step3: (Optional) If you see “INTERNET AVAILABILITY ADDRESS” in “Network” → “WAN”, make sure a valid address, such as *www.google.com*, in your country is entered to help the recorder determine whether the network setup is successfully or not when the setup is completed later.

Step4: Select **“STATIC”**, **“PPPOE”** or **“DHCP”** based on your network type, and change the port number if needed.

- For **“STATIC”**, enter the information of the static IP address, gateway and net mask from your ISP, and go to the next section, “Check your connection – via Internet Explorer” directly to examine your setup.
- For **“PPPOE”**, enter the DNS address, user name and password from your ISP, assign a port number (if necessary), and go to “Step4” to continue.

Note: The default port number is 80. Typically, the TCP port used by HTTP is 80. However in some cases, it is better to change this port number for added flexibility or security.

- For **“DHCP”**, go to “Step4” to continue.

Step5: (**PPPOE & DHCP** Only) Go to “DDNS”, and select “eagleeyes” in “SYSTEM NAME”.

Note down the whole address under “CURRENT HOST ADDRESS”, such as **MAC000E5318B3F0.ddns.dvrtw.com.tw**. This will be the address used to access your video recorder remotely.

ADVANCED CONFIG					
CONNECTION	WAN	LAN	E-MAIL	DDNS	
CAMERA	DDNS				ON
DETECTION	SYSTEM NAME				eagleeyes
ALERT	HOST NAME				MAC000E5318B3F0
NETWORK	E-MAIL				EMPTY
DISPLAY					
RECORD					
CURRENT HOST ADDRESS					
MAC000E5318B3F0.ddns.dvrtw.com.tw					
EXIT					

Then, select “EXIT” to return to the live view.

Check your connection – via status icon of recorder

Check the operation guide of your recorder and see if your recorder has the following status icons:



(WAN) Internet connected



(WAN) Local connection



(WAN) Internet disconnected

If yes, check the icon on the status bar of your recorder, and make sure you see . If no, please start from Step1 again.

Check your connection – via Internet Explorer

Step1: Disconnect the network connection between your laptop and the router, and connect your laptop to other wireless network if possible.

Note: If there’s no other wireless connection available for your laptop, this method is not suitable for you. Please go to the next section, **“Check your connection – via iOS® / Android™ mobile device”**.

Step1: Open your web browser, e.g. Internet Explorer.

Step2: Enter the IP address (**STATIC**) or host address (**PPPOE / DHCP**), and the port number in the URL address box of the web browser, and see if you can access the login page successfully.

The format is **“http://ipaddress:portnum”** or **“http://hostaddress:portnum”**, for example, **“http://MAC000E5318B3F0.ddns.dvrtw.com.tw:88”**.

If no, the network setup is failed. Please start from Step1 again.

Check your connection – via iOS® / Android™ mobile device

Step1: Download our free mobile app, EagleEyes, from App StoreSM (iOS device) or Google PlayTM (Android device).

Note: App Store is a service mark of Apple Inc. iOS is the trademark of Apple Inc., registered in the U.S. and other countries. Google Play is the trademark of Google Inc.

Step2: Switch the network mode to 3G mode or other wireless network on your iOS / Android device.

Step3: Open EagleEyes, and select “Manual” when you’re prompted to choose the setup method.

Step4: Click “+” on the bottom to enter the configuration page.

Then, enter the IP address (**STATIC**) or host address (**PPPOE / DHCP**), port number, user name and password of your video recorder.

In our example, the address is **MAC00E5318B3F0.ddns.dvrtw.com.tw**, the port number is **88**, and the user name and password are both **admin** by default (if they haven’t been changed).

Step5: Select “Get Type” to see if you can get the type of your video recorder. If no, the network setup is failed. Please start from Step1 again.

