

WAT-902B 1/2" Low Noise · High Sensitivity Camera

High cost performance model among the WAT-902 series



Key features

- High sensitivity with low noise operation
- Min. illumination 0.003 lx F1.4 (AGC HIGH=32dB, Shutter=OFF)

Dimensions

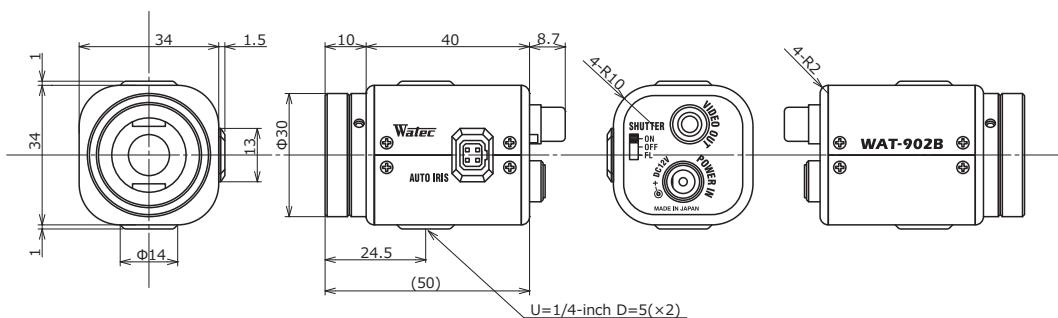

Specifications

Video standard		EIA	CCIR
Pick-up element		1/2 inch interline transfer CCD image sensor	
Number of effective pixels		768(H) × 494(V)	752(H) × 582(V)
Unit cell size		6.35μm(H) × 7.4μm(V)	8.6μm(H) × 8.3μm(V)
Synchronizing system		Internal	
Scanning system		2:1 interlace	
Video output		Composite video, 1.0 V(p-p) 75Ω (Unbalanced)	
Resolution (H)		More than 570TVL (Center)	
Minimum illumination		0.003 lx F1.4 (AGC HIGH=32dB, Shutter=OFF)	
S/N		More than 50dB (AGC OFF=10dB, γ=1.0)	
Function settings		DIP Switch	
AE mode	Fixed	1/60, 1/100 sec.	1/50, 1/120 sec.
	EI	1/60 - 1/100000 sec.	1/50 - 1/100000 sec.
AGC	ON	5 - 20dB (LOW), 5 - 32dB (HIGH)	
	OFF	10dB	
MGC		-	
Gamma characteristics		γ≐0.45, 1.0	
Video level		100IRE	
Noise reduction		-	
Wide dynamic range		-	
Lens iris		Video (Watec original arrangement)	
Back light compensation		BLC	
White blemish correction		-	
Sharpness		-	
Defog		-	
Digital zoom		-	
Privacy mask		-	
Mirror image		-	
Freeze		-	
Motion detection		-	
Neg.image		-	
Interface		RCA (Composite Video), Power in, Auto iris	
Power supply		DC+12V±10%	
Power consumption		1.74W (145mA)	
Operating temperature		-10 - +40°C	
Storage temperature		-30 - +70°C	
Operating / Storage humidity		95% RH or less (Without condensation)	
Lens mount		CS mount	
Weight		Approx. 86g	
Accessories		WPDC12 (DC plug), AIC (Iris plug)	

Options

CS-mount lenses

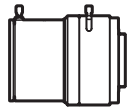

*see www.variovision.tv for lens options

C-mount lenses

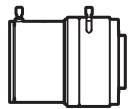

*see www.variovision.tv for lens options

C-mount adaptor



*402806

30CMA-R

Miniature lenses / Mount adaptors



0814BC-12
*401618



22PMA-M12-125
*401595



3745B-13P
*402825



22PMA-M13-040
*401596

WAT-902B

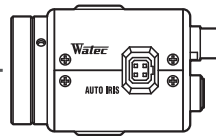

VIDEO OUT (BNC)



POWER IN (DC12V)



Cables

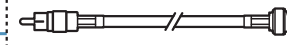

3C2V (BNC/RCA) *402607-xx

BNC

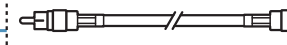

3C2V (RCA/RCA)

RCA



*see www.variovision.tv for options

Power supply adaptors



SWI12-12-N-P5

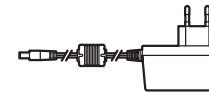

SWI12-12-E-P5 *303046

Stands



MS50
*402599



WH-31
*303040

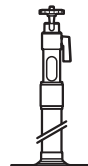

WH-11
*303041

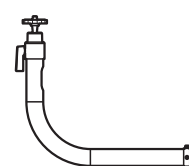

WH-21
*303042

Water resistant camera housing / Mounting brackets



VCHO-15S



WH-6N



PTP-300

*see www.variovision.tv for more options

*xxxxx = Variovision Art.N.